

# LPR12/48-150-IP68

Technical Guide: 0120048-J0

Effective: 08/2018

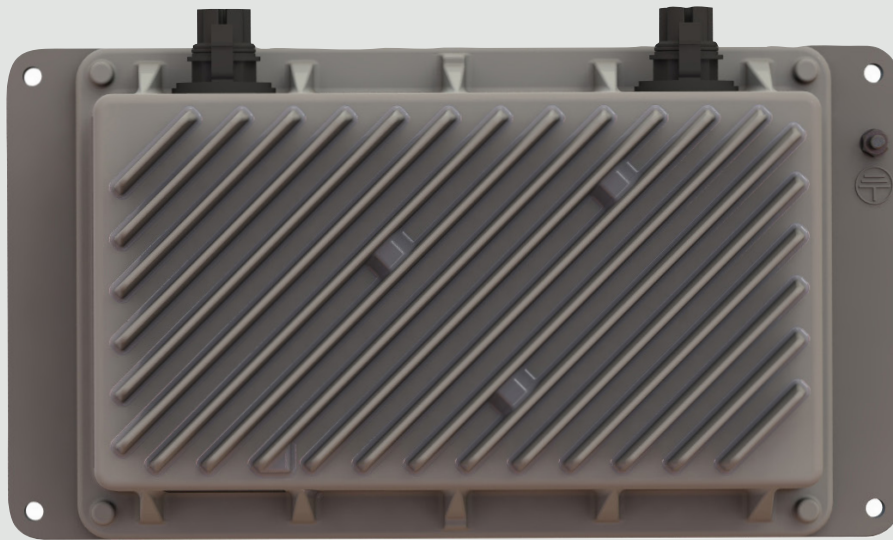



# LPR12-150-IP68

# LPR48-150-IP68

 **NOTE:**

---

**Photographs contained in this manual are for illustrative purposes only. These photographs may not match your installation.**

 **NOTE:**

---

**Operator is cautioned to review the drawings and illustrations contained in this manual before proceeding. If there are questions regarding the safe operation of this powering system, contact Alpha Technologies or your nearest Alpha representative.**

 **NOTE:**

---

**Alpha shall not be held liable for any damage or injury involving its enclosures, power supplies, generators, batteries, or other hardware if used or operated in any manner or subject to any condition inconsistent with its intended purpose, or if installed or operated in an unapproved manner, or improperly maintained.**

For technical support, contact Alpha Technologies:

Canada and USA: **1-888-462-7487**

International: **+1-604-436-5547**

## Copyright

Copyright © 2018 Alpha Technologies Ltd. All rights reserved. Alpha is a registered trademark of Alpha Technologies.

No part of this documentation shall be reproduced, stored in a retrieval system, translated, transcribed, or transmitted in any form or by any means manual, electric, electronic, electromechanical, chemical, optical, or otherwise without prior explicit written permission from Alpha Technologies.

This document, the software it describes, and the information and know-how they contain constitute the proprietary, confidential and valuable trade secret information of Alpha Technologies, and may not be used for any unauthorized purpose, or disclosed to others without the prior written permission of Alpha Technologies.

The material contained in this document is for information only and is subject to change without notice. While reasonable efforts have been made in the preparation of this document to assure its accuracy, Alpha Technologies assumes no liability resulting from errors or omissions in this document, or from the use of the information contained herein. Alpha Technologies reserves the right to make changes in the product design without reservation and without notification to its users.



# Table of Contents

1. Safety.....	5
1.1 Safety Symbols.....	5
1.2 General Warnings and Cautions.....	5
1.3 Electrical Safety.....	6
2. Product Overview.....	7
2.1 Scope of the Manual.....	7
2.2 Introduction.....	7
2.3 Part Number.....	7
2.4 Product Features.....	8
3. Product Specifications.....	9
4. Pre-installation Requirements.....	10
4.1 Effective Capacitance.....	10
4.2 RFT-V Circuits.....	10
4.3 Primary Protection.....	10
4.4 Installation Locations.....	10
5. Inspection.....	11
5.1 Packing Materials.....	11
5.2 Check for Damage.....	11
5.3 General Receipt of Shipment.....	11
6. Installation.....	12
6.1 Safety Precautions.....	12
6.2 Tools Required.....	12
6.3 Module Preparation/Mounting.....	12
7. Wiring.....	13
7.1 DC Input and Output/Alarm Connectors.....	13
7.2 LPR Cable Kit.....	15
8. Initial Start Up.....	17
8.1 Normal Mode of Operation.....	17
8.2 Reverse Polarity Protection.....	17

- 9. Warranty Statement and Service Information ..... 18
  - 9.1 Technical Support ..... 18
  - 9.2 Warranty Statement ..... 18
  - 9.3 Product Warranty ..... 18
  - 9.4 Battery Warranty ..... 18
  - 9.5 Warranty Claims..... 18
  - 9.6 Service Information ..... 18
- 10. Acronyms and Definitions ..... 19
- 11. Certification ..... 20

**List of Figures**

- Figure 1 — Front View of the LPRxx-150-IP168..... 7
- Figure 2 — Output and Input Connector View ..... 13
- Figure 3 — Detail A, Output/Alarm..... 14
- Figure 4 — Detail B, Input..... 14
- Figure 5 — DC Input Cable Connector ..... 15
- Figure 6 — Anderson Power Products (APP) tool (PM100G1)..... 15
- Figure 7 — DC Output/Alarm Cable Connector..... 16
- Figure 8 — Anderson Power Products (APP) tool (PM100G1)..... 16

# 1. Safety

---

**SAVE THESE INSTRUCTIONS:** This manual contains important safety instructions that must be followed during the installation, servicing, and maintenance of the product. Keep it in a safe place. Review the drawings and illustrations contained in this manual before proceeding. If there are any questions regarding the safe installation or operation of this product, contact Alpha Technologies or the nearest Alpha representative.

## 1.1 Safety Symbols

To reduce the risk of injury or death, and to ensure the continued safe operation of this product, the following symbols have been placed throughout this manual. Where these symbols appear, use extra care and attention.

The use of **ATTENTION** indicates specific regulatory/code requirements that may affect the placement of equipment and/or installation procedures.

 **NOTE:**  
**A NOTE provides additional information to help complete a specific task or procedure. Notes are designated with a checkmark, the word NOTE, and a rule beneath which the information appears**

 **CAUTION!**  
**CAUTION indicates safety information intended to PREVENT DAMAGE to material or equipment. Cautions are designated with a yellow warning triangle, the word CAUTION, and a rule beneath which the information appears.**

 **WARNING!**  
**WARNING presents safety information to PREVENT INJURY OR DEATH to personnel. Warnings are indicated by a shock hazard icon, the word WARNING, and a rule beneath which the information appears.**

 **HOT!**  
**The use of HOT presents safety information to PREVENT BURNS to the technician or user.**

## 1.2 General Warnings and Cautions

 **WARNING!**  
**You must read and understand the following warnings before installing the enclosure and its component. Failure to do so could result in personal injury or death.**

- Read and follow all instructions included in this manual.
- Only trained personnel are qualified to install or replace this equipment and its components.
- Use proper lifting techniques whenever handling equipment, parts, or batteries.

## 1.3 Electrical Safety



### WARNING!

**Hazardous voltages are present at the input of power systems. The DC output from rectifiers and batteries, though not dangerous in voltage, has a high short-circuit current capacity that may cause severe burns and electrical arcing.**

Before working with any live battery or power system, follow these precautions:

- a. Remove all metallic jewelry, such as watches, rings, metal rimmed glasses, or necklaces.
- b. Wear safety glasses with side shields at all times during the installation.
- c. Use OSHA approved insulated hand tools. Do not rest tools on top of batteries.



### WARNING!

**Lethal voltages are present within the power system. Always assume that an electrical connection or conductor is energized. Check the circuit with a voltmeter with respect to the grounded portion of the enclosure (both AC and DC) before performing any installation or removal procedure.**

- Do not work alone under hazardous conditions.
- A licensed electrician is required to install permanently wired equipment. Input voltages can range up to 240 Vac. Ensure that the utility power is disconnected and locked out before performing any installation or removal procedure.
- Ensure that no liquids or wet clothes come into contact with internal components.
- Hazardous electrically live parts inside this unit are energized from the batteries even when the AC input power is disconnected.
- The enclosure which contains the DC or AC power system must remain locked at all times, except when authorized service personnel are present.
- Always assume electrical connections or conductors are live. Turn off all circuit breakers and double-check with a voltmeter before performing installation or maintenance.
- Place a warning label on the utility panel to warn emergency personnel that a reserve battery source is present which will power the loads in a power outage condition or if the AC disconnect breaker is turned off.
- At high ambient temperature conditions, the internal temperature can be hot so use caution when touching the equipment.



## 2. Product Overview

---

### 2.1 Scope of the Manual

This instruction manual explains the installation and interconnection of Alpha Technologies' LPR12-150-IP68 and LPR48-150-IP68 converter system. To aid with installation, frequent reference is made to the drawings located at the rear of the manual.

### 2.2 Introduction

The LPRxx-150-IP68 is a compact, sealed, standalone, RFT-V line powering down-converter unit designed for remote site powering applications using +/- 190Vdc (RFT-V circuit) over twisted copper pairs. The LPRxx-150-IP68 provides a bulk regulated nominal 12 or -48Vdc output from two twisted copper pairs, with maximum power of 150W.

Line Powering Network (a.k.a. Express, Simplex, Remote, Centralized) is a method of distributing energy over an existing copper network. Multiple twisted-pair copper is used to distribute 100VA limited power sources at  $\pm 190$ Vdc. The individual, isolated inputs are terminated at a remote end and converted back to a bulk 12Vdc or 48Vdc supply.

Power holdup capabilities are incorporated into the LPRxx-150-IP68 to provide at least 150 millisecond of backup for a 100 W load. The holdup prevents potential lengthy customer communication outages due to remote node resetting caused by line surges and ensure maximum reliability.

See the Features section for more information. The Specifications Section of this manual, details the electrical ratings.

### 2.3 Part Number

This product is available to order under the following part numbers:

<b>LPR12-150-IP68</b>	<b>0370421-001</b>
<b>LPR48-150-IP68</b>	<b>0370414-001</b>

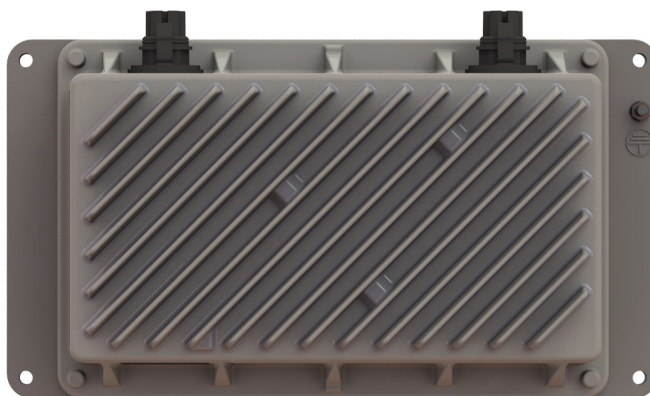

Figure 1 — Front View of the LPRxx-150-IP68

## **2.4 Product Features**

### **Output Power**

Each of the two isolated converters on each LPRxx-150-IP68 module has a maximum output capacity of 75W (for a total capacity of 150W per module). The power output is a function of the input voltage into each converter. Proper network engineering and copper pair sizing is a requirement for meeting the power demand of the load.

### **Current Limit**

The current limiting function provides a primary response to output overload situations.

### **Input Low Voltage Protection**

The converter module is electronically protected from low voltages at the inputs by fault detection circuitry. If the input to the converter module falls below the lower DC input limit (see Specifications), the module will shut down.

### **Reverse Polarity Protection**

The converter design has incorporated reverse polarity protection from the connection to a power source on the input. This prevents damage to the converter circuitry if a reverse connection is made.

### **Module Alarm Relay**

The module alarm relay (Form C dry contact) is deenergized (i.e., NO to Com is open) if any or both of the two channel outputs fail.

### 3. Product Specifications

Electrical	
<b>Input voltage:</b>	200 to 380Vdc (+/- 100 to +/- 190Vdc)
<b>Number of Inputs:</b>	2
<b>Input Current per feed:</b>	245mA max
<b>Output voltage:</b>	LPR12-150-IP68: 12 to 14Vdc LPR48-150-IP68: -54 to -56Vdc
<b>Power:</b>	up to 150W (the power available from the unit depends on the distance from the up-converter and wire gauge of the twisted copper pairs)
<b>Output Current:</b>	12.5A (12V) at full rated load of 150W (de-rates with input voltage) 2.74A (48V) at full rated load of 150W (de-rates with input voltage)
<b>Efficiency:</b>	86% (12V) at nominal output 89.5% (48V) at nominal output
<b>Regulation:</b>	<2% no load to full load <1% line
<b>Electrical Noise:</b>	100mVRMS to 20MHz (wide band) <500mVp-p to 20MHz
<b>Hold up Time:</b>	>150 millisecond at 100W load
<b>Load Sharing:</b>	+/- 10%
Mechanical	
<b>Dimensions (HxWxD):</b>	millimeters: 70H x 255W x 140D inches: 2.8H x 10.0W x 5.5D
<b>Weight:</b>	1.7 kg (3.7 .lb)
<b>Connections:</b>	Requires LPR cable kit with pre-connectorized input and output cable
Environmental	
<b>Temperature Operating:</b>	-40 to 65°C (-40 to 149°F)
<b>Temperature Storage:</b>	-40 to 85°C (-40 to 185°F)
<b>Environmental Protection:</b>	IP68 (immersion in 6ft (2m) of water for 24 hours)
<b>Humidity</b>	5 to 100% RH non-condensing
<b>Altitude:</b>	-500 to 2000m (-1640 to 6562ft).
Performance / Features	
<b>Alarm Relays:</b>	Form C contact
Agency Compliance	
<b>Safety:</b>	IEC/CSA/UL 60950-1 Compatible with IEC/CSA/UL 60950-21 (RFT-V circuit) IEC/CSA/UL 60950-22 Low Voltage Directive 2006/95/EC
<b>EMC:</b>	CFR47 (FCC) Part 15 Class B EN 300 386 v1.6.1 EMC Directive 2014/30/EC

## 4. Pre-installation Requirements

---

### 4.1 Effective Capacitance

At the time of installation, carry out a system assessment to ensure that the effective capacitance of the total system, including the capacitance from the output of the up-converter (front-end), does not exceed 11 $\mu$ F (Line to Earth) and 40 $\mu$ F (Line to Line).

### 4.2 RFT-V Circuits

At the time of installation, ensure that the voltage rating of the wiring of the telecommunication network is adequate for the normal RFT circuit voltage (+/-200Vdc), together with superimposed transients.

Ensure that the circuits to be connected together are all RFT-V circuits.

### 4.3 Primary Protection

The LPR Series has built-in surge protection across the input terminals in compliance with the GR-1089-CORE requirement. External primary protection is recommended for outdoor aerial installation.

### 4.4 Installation Locations

Allowable installation locations for the LPR converters include the following: outdoors, direct sunlight, and inside or outside a cabinet.

# 5. Inspection







## 5.1 Packing Materials

Alpha is committed to providing products and services that meet our customers' needs and expectations in a sustainable manner, while complying with all relevant regulatory requirements. As such Alpha strives to follow our quality and environmental objectives from product supply and development through to the packaging for our products.

Rectifiers and batteries are shipped on individual pallets and are packaged according to the manufacturer's guidelines.

Almost all of Alpha's packaging material is from sustainable resources and/or is recyclable. See the following table for the material and its environmental codes.

### 5.1.1 Returns for Service

 PAP/PCB	 PET	 PE-LD	 PS	 FE	 ALU	 NW
<b>Cardboard</b>	<b>Polyethylene Terephthalate</b>	<b>Low Density Polyethylene</b>	<b>Polystyrene</b>	<b>Steel</b>	<b>Aluminum</b>	<b>Wood</b>
Packing boxes Caps	Flexible film Packaging	Bubble wrap Shrink wrap Plastic bags	Foam	Strapping on pallets	Strapping on pallets	Pallets Lumber

Save the original shipping container. If the product needs to be returned for service, it should be packaged in its original shipping container. If the original container is unavailable, make sure that the product is packed with at least three inches of shock-absorbing material to prevent shipping damage.

Alpha Technologies is not responsible for damage caused by improper packaging of returned products.

## 5.2 Check for Damage

Before unpacking the product, note any damage to the shipping container. Unpack the product and inspect the exterior for damage. If any damage is observed, contact the carrier immediately.

Continue the inspection for any internal damage. In the unlikely event of internal damage, inform the carrier and contact Alpha Technologies for advice on the impact of any damage.

## 5.3 General Receipt of Shipment

The inventory included with your shipment depends on the options you have ordered. The options are clearly marked on the shipping container labels and bill of materials.

Call Alpha Technologies if you have any questions before you proceed: 1 888 462-7487.

# 6. Installation

---

This chapter is provided for qualified personnel to install the product, which shall be mounted in the most non extreme environment. The installer should follow all applicable local rules and regulations for electrical and battery installations; e.g., CSA, UL, CEC, NEC, OSHA, and local fire codes.

## 6.1 Safety Precautions



### WARNING!

**This system is designed to be installed in a restricted access location that is inaccessible to the general public.**

Refer to the Safety section near the front of this manual.

## 6.2 Tools Required

Various insulated tools are essential for the installation.

Use this list as a guide:

- Electric drill with hammer action, 1/2" capacity.
- Various crimping tools and dies to match lugs used in installation.
- Digital voltmeter equipped with test leads.
- Cutters and wire strippers (#14 to #22 AWG) [2.5 to 0.34 mm<sup>2</sup>].

## 6.3 Module Preparation/Mounting

For detailed information refer to 0120048-08 drawing at the rear of this manual.

Recommended hardware:

- 4x #10 screws or bolts
- 4x #10 flat narrow washers with 0.75" OD max.

The LPRxx-150-IP68 can be mounted to surfaces with #10 (M5) fastening hardware in four locations. Alpha recommends using flat washers for improved fastening.

# 7. Wiring



## WARNING!

For safety reasons, ensure the shelf is properly bonded to the enclosure's ground grid. Input voltage shall meet UL60950-21 RFT-V requirements. **DO NOT CONNECT TO RFT-C CIRCUITS.**

Chassis must be permanently grounded.

-48V return (RTN) shall be earthed.

Telecom cable carrying  $\pm 190V$ , shall be #26 AWG minimum (rated 200V minimum).

Primary over voltage protection must be provided on all input pairs.

Insulation of the outside plant conductors should be rated  $>90^{\circ}C$  ( $194^{\circ}F$ ).

Insulation of the wiring inside the enclosed equipment cabinets should be rated  $105^{\circ}C$  ( $221^{\circ}F$ ) minimum. Cables must be dressed to avoid damage to the conductors.



## CAUTION!

This equipment is intended to be used in outdoor environments.

Load connections should be made in close proximity to the power output.

### 7.1 DC Input and Output/Alarm Connectors

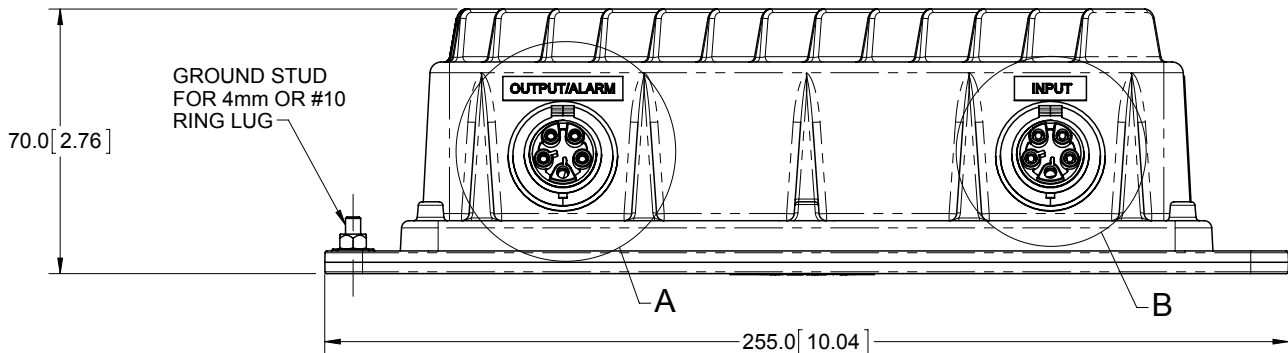

Figure 2 — Output and Input Connector View

	PIN #	CIRCUIT DESIGNATION (48V)	CIRCUIT DESIGNATION (12V)
OUTPUT	2	-48V	GND
	3	48V_RTN	+12V
ALARM	4	K1_COMMON	
	5	K1_NO	

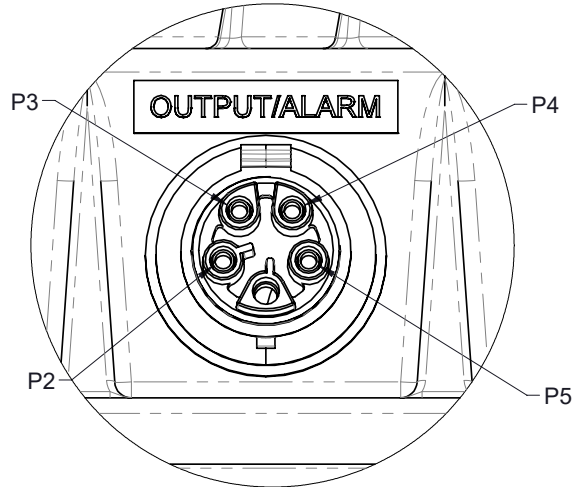

Figure 3 — Detail A, Output/Alarm

	PIN #	CIRCUIT DESIGNATION (48V)
INPUT A	5	+190V_ChA
	4	-190V_ChA
INPUT B	2	+190V_ChB
	3	-190V_ChB

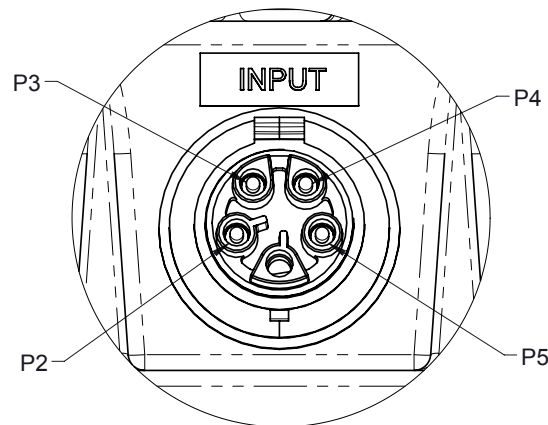

Figure 4 — Detail B, Input



## 7.2 LPR Cable Kit

The LPR cable kit included provides a set of two, 2m (6ft) long cables each with one cut cable end, and one end pre-terminated with an LPR mating connector. The kit contains:

- Input cable
- Output/Alarm cable

### 7.2.1 DC Input

DC Input cable use: 4x #22AWG. Use the following mating cables for DC input connections. Crimp with Anderson Power Products (APP) tool (PM100G1).



Figure 6 — Anderson Power Products (APP) tool (PM100G1).

Input	Wire Color	Circuit Designation
Input A	Blue/White	+190V_ChA
	Blue	-190V_ChA
Input B	Orange	-190V_ChB
	Orange/White	+190V_ChB

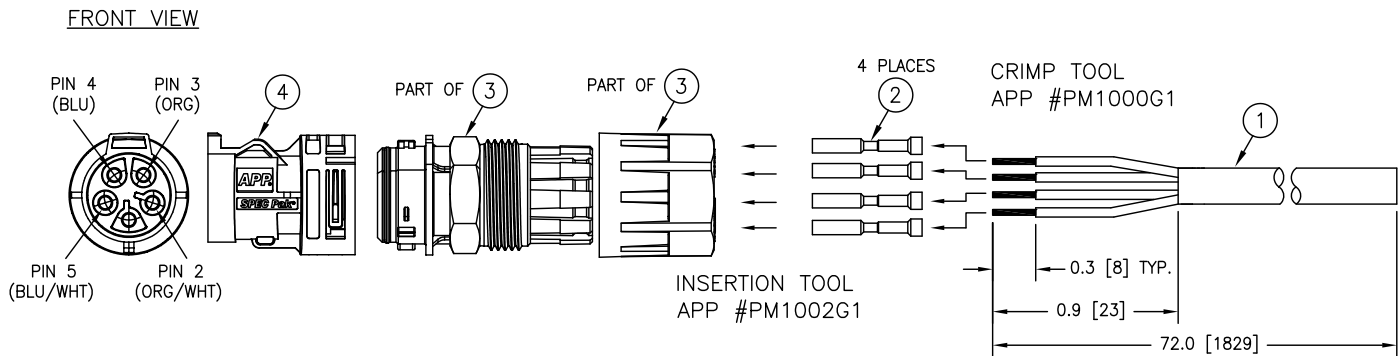

Figure 5 — DC Input Cable Connector

	Description	Alpha PN	Manufacturer PN
4	Heavy duty Power Connectors, 5 Positions, MINI, 22A, IP68, UV and Flame Resistant Plastic	5450299	APP SK1-021M05
3	Sealing Gland, 5 Postillions, IP68, UV and Flame Resistant Plastic	5450300	APP PS1T24-11X
2	Heavy Duty Power Connector Socket, 24-20AWG, Gold Plated	5380190	APP PM16S2024S32
1	Cable, 4 Conductors, 22AWG, Solid, Shielded, Direct Burial (Qty - 6ft)	8580054	Superior Essex 04-052-84

## 7.2.2 DC Output/Alarm

DC Output/Alarm cable use: 4x #14AWG. Use the following mating cable assembly for DC output connections. Crimp with Anderson Power Products (APP) tool (PM1000G1).



Figure 8 — Anderson Power Products (APP) tool (PM100G1).

Output	Wire Color	Circuit Designation	
		LPR48-150-IP68	LPR12-150-IP68
Output	Black	-48V	GND
	Red	48V_RTN	+12V
Alarm	Green	K1_COMMON	
	White	K1_NO	

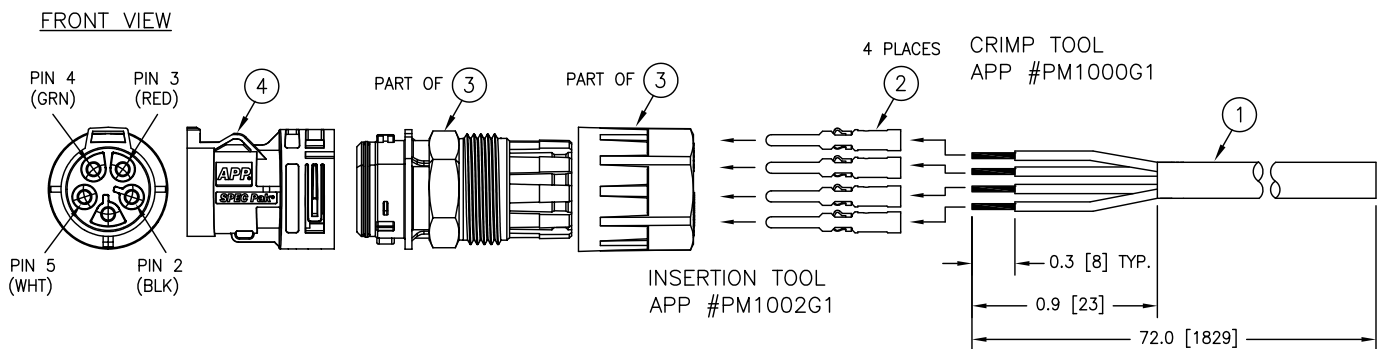

Figure 7 — DC Output/Alarm Cable Connector

	Description	Alpha PN	Manufacturer PN
4	Heavy duty Power Connectors, 5 Positions, MINI, 22A, IP68, UV and Flame Resistant Plastic	5450299	APP SK1-019M05
3	Sealing Gland, 5 Postillions, IP68, UV and Flame Resistant Plastic	5450300	APP PS1T24-11x
2	Heavy Duty Power Connector Pin, 16-14AWG, Gold Plated	5380178	APP PM16P1416S30
1	Portable Cord Cable, 4 Conductors, 14AWG, SJ00W Type, Standard, 300V (Qty - 6ft)	8580053	General Cable HF343 or equivalent

## 8. Initial Start Up

---

1. Remove customer-supplied 5-pin protectors (if available) from power-pairs termination block and disconnect the output -48V cable.
2. Verify by both measurement and observation that the chassis of the system is bonded to ground.
3. Connect module input cable to the host system
4. Complete the input circuits by plugging in the 5-pin protectors.
5. Measure the output voltage to be <14Vdc for LPR12-150 or <56Vdc for LPR48-150 and reconnect the output cable.

### 8.1 Normal Mode of Operation

Normal operation of the converter system will be indicated by the presence of voltage on the converter output cables.

### 8.2 Reverse Polarity Protection

The converter will not be damaged and will operate if an input connection is made in reverse.

## 9. Warranty Statement and Service Information

---

### 9.1 Technical Support

In Canada and the USA, call toll free 1-888-462-7487.

Customers outside Canada and the USA, call +1-604-436-5547.

### 9.2 Warranty Statement

For full information details review Alpha's online Warranty Statement at [www.alpha.ca/support](http://www.alpha.ca/support).

### 9.3 Product Warranty

Alpha warrants that for a period of two (2) years from the date of shipment its products shall be free from defects under normal authorized use consistent with the product specifications and Alpha's instructions, the terms of the manual will take precedence.

The warranty provides for repairing, replacing or issuing credit (at Alpha's discretion) for any equipment manufactured by it and returned by the customer to the factory or other authorized location during the warranty period.

There are limitations to this warranty coverage. The warranty does not provide to the customer or other parties any remedies other than the above. It does not provide coverage for any loss of profits, loss of use, costs for removal or installation of defective equipment, damages or consequential damages based upon equipment failure during or after the warranty period. No other obligations are expressed or implied. Warranty also does not cover damage or equipment failure due to cause(s) external to the unit including, but not limited to, environmental conditions, water damage, power surges or any other external influence.

The customer is responsible for all shipping and handling charges. Where products are covered under warranty Alpha will pay the cost of shipping the repaired or replacement unit back to the customer.

### 9.4 Battery Warranty

Note that battery warranty terms and conditions vary by battery and by intended use. Contact your Alpha sales representative or the Technical Support team at the above number to understand your entitlements under Battery Warranty.

### 9.5 Warranty Claims

Any claim under this Limited Warranty must be made in writing to Alpha BEFORE sending material back. Alpha will provide Product return instructions upon approval of return request. A Service Repair Order (SRO) and / or Return Authorization (RA) number will be issued ensuring that your service needs are handled promptly and efficiently.

Claims must be made online at: [www.alpha.ca](http://www.alpha.ca).

### 9.6 Service Information

For a list of international service centers, refer to the Alpha website: [www.alpha.ca](http://www.alpha.ca)

## 10. Acronyms and Definitions

---

AC	Alternating current
AWG	American wire gauge
CEC	Canadian Electrical Code
CMA	Circular mil area
CSA	Canadian Standards Association
DC	Direct current
LED	Light emitting diode
LPR	Line Powering Remote
NC	Normally closed
NEC	National Electrical Code (for the USA)
NO	Normally open
OSHA	Occupational Safety & Health Administration
OVP	Over voltage protection
RU	Rack unit (1.75")
UL	Underwriters Laboratories

# 11. Certification

## About CSA and NRTL

CSA (Canadian Standards Association also known as CSA International) was established in 1919 as an independent testing laboratory in Canada. CSA received its recognition as an NRTL (Nationally Recognized Testing Laboratory) in 1992 from OSHA (Occupational Safety and Health Administration) in the United States of America (Docket No. NRTL-2-92). This was expanded and renewed in 1997, 1999, and 2001. The specific notifications were posted on OSHA's official website as follows:

- Federal Register #: 59:40602 - 40609 [08/09/1994]
- Federal Register #: 64:60240 - 60241 [11/04/1999]
- Federal Register #: 66:35271 - 35278 [07/03/2001]

When these marks appear with the indicator “C and US” or “NRTL/C” it means that the product is certified for both the US and Canadian markets, to the applicable US and Canadian standards. (1)

Alpha rectifier and power system products, bearing the aforementioned CSA marks, are certified to CSA C22.2 No. 60950-01 and UL 60950-01. Alpha UPS products, bearing the aforementioned CSA marks, are certified to CSA C22.2 No. 107.3 and UL 1778.

As part of the reciprocal, US/Canada agreement regarding testing laboratories, the Standards Council of Canada (Canada's national accreditation body) granted Underwriters Laboratories (UL) authority to certify products for sale in Canada. (2)

Only Underwriters Laboratories may grant a licence for the use of this mark, which indicates compliance with both Canadian and US requirements. (3)



## NRTLs capabilities

NRTLs are third party organizations recognized by OSHA, US Department of Labor, under the NRTL program.

The testing and certifications are based on product safety standards developed by US based standards developing organizations and are often issued by the American National Standards Institute (ANSI). (4)

The NRTL determines that a product meets the requirements of an appropriate consensus-based product safety standard either by successfully testing the product itself, or by verifying that a contract laboratory has done so, and the NRTL certifies that the product meets the requirements of the product safety standard. (4)

## Governance of NRTL

The NRTL Program is both national and international in scope with foreign labs permitted.

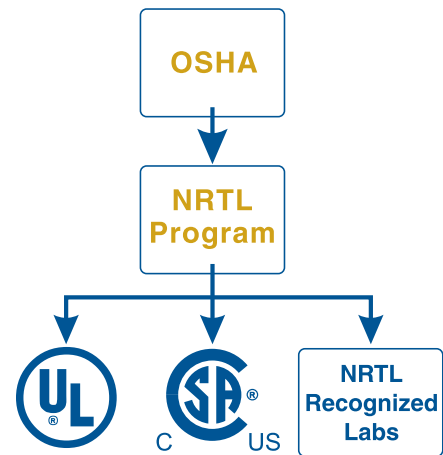

(1) [www.csagroup.org](http://www.csagroup.org)

(2) [www.scc.ca](http://www.scc.ca)

(3) [www.ulc.ca](http://www.ulc.ca)

(4) [www.osha.gov](http://www.osha.gov)

REVISIONS		LTR	DESCRIPTION	DWN	DATE	CHK
B	ADDED CONNECTOR CAPS	ZL			May-20-16	KLAU

DO NOT SCALE DRAWING

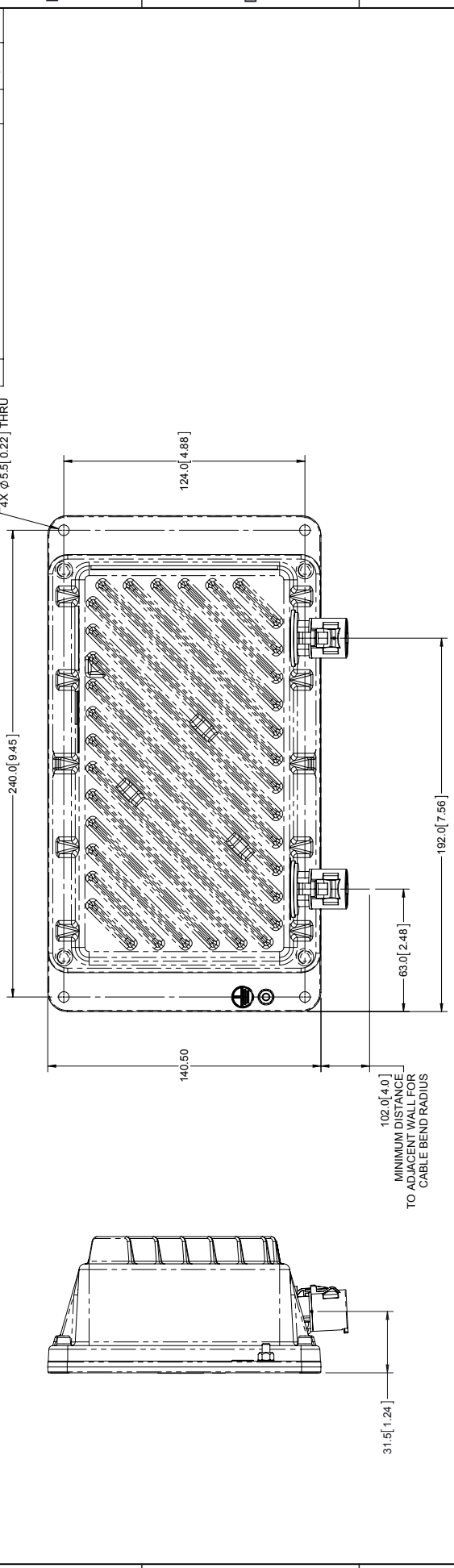

PIN #	CIRCUIT DESIGNATION
2	GND
3	+12V
4	K1_COMMON
5	K1_NO

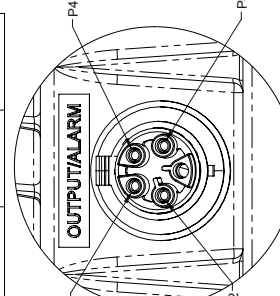

DETAIL A  
SCALE: 1 : 1

PIN #	CIRCUIT DESIGNATION
5	+180V_CHA
4	-180V_CHA
2	+180V_CHB
3	-180V_CHB

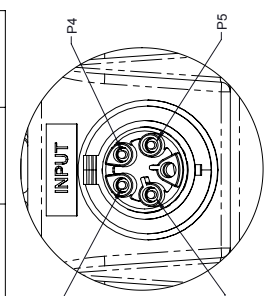

DETAIL B  
SCALE: 1 : 1

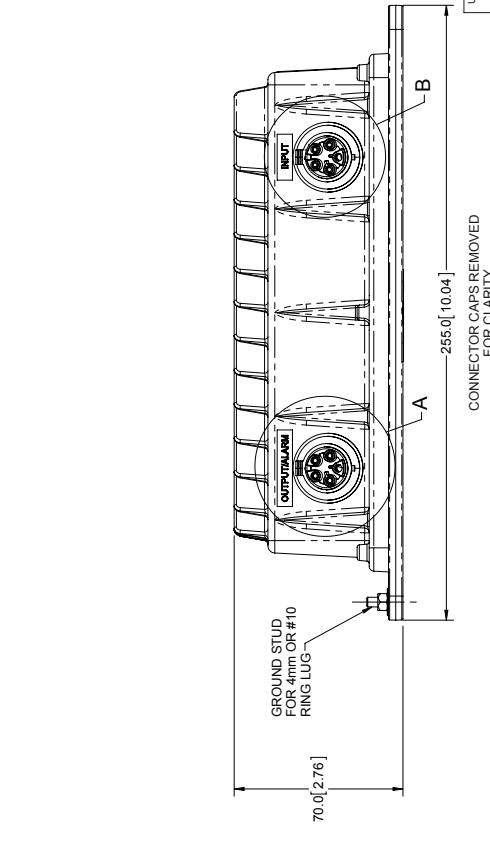

CONNECTOR CAPS REMOVED FOR CLARITY

UNLESS OTHERWISE SPECIFIED DIM ARE IN MM  
 X .X  
 X.X  
 X.XX  
 ANGULAR : 1°  
 INTERSECTING DIM AND CL PER ANSI Y14.5  
 THIRD ANGLE PROJECTION

THESE DESIGNS AND SPECIFICATIONS ARE CONFIDENTIAL. REMAIN THE PROPERTY OF ALPHA TECHNOLOGIES LTD. AND SHALL NOT BE COPIED OR USED WITHOUT ITS WRITTEN CONSENT.

APPROVALS  
 DRAWN: ZL  
 CHECKED: TZ  
 DATE: Apr-15-16

TITLE: OUTLINE CONNECTION DRAWING, LPR12-150-IP68

© ALPHA TECHNOLOGIES LTD  
 SCALE: 1:2 SHEET 1 OF 1

DO NOT SCALE DRAWING

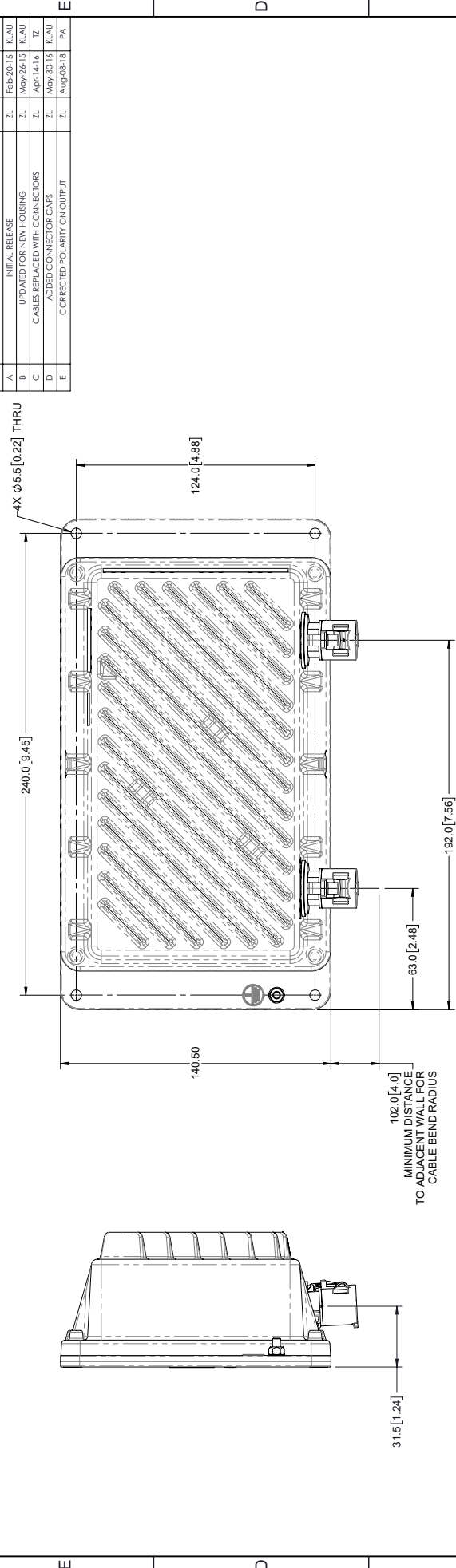

CIRCUIT DESIGNATION	PIN #
OUTPUT	2
ALARM	3
	4
	5

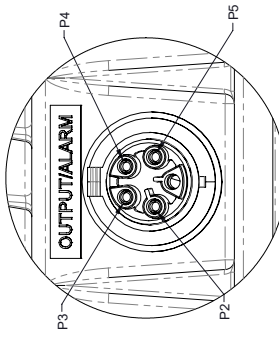

DETAIL A  
SCALE: 1 : 1

CIRCUIT DESIGNATION	PIN #
INPUT A	5
INPUT B	4
	2
	3

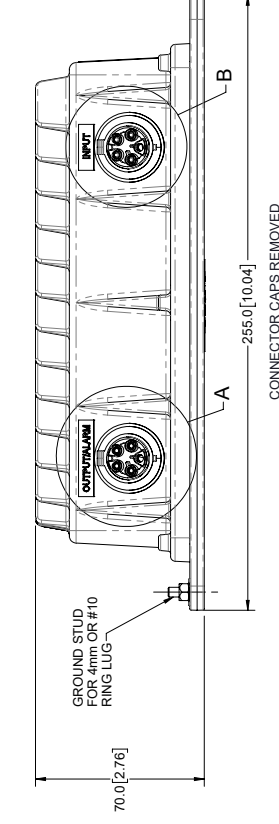

DETAIL B  
SCALE: 1 : 1

LTR	DESCRIPTION	DWN	DATE	CHK
A	INITIAL RELEASE	ZL	Feb-20-15	KLAU
B	UPDATED FOR NEW HOUSING	ZL	May-26-15	KLAU
C	CABLES REPLACED WITH CONNECTORS	ZL	Apr-14-16	TZ
D	ADDED CONNECTOR CAPS	ZL	May-30-16	KLAU
E	CORRECTED POLARITY ON OUTPUT	ZL	Aug-08-18	PA

UNLESS OTHERWISE SPECIFIED  
DIM ARE IN MM

X, X.X  
X.XX  
X.XXX  
ANGULAR:  
INTERPRET DIM AND TOL PER  
ASME Y14.5M-2009

THIRD ANGLE PROJECTION

© ALPHA TECHNOLOGIES LTD

SCALE: 1:2 SHEET 1 OF 1

REVISIONS

APPROVALS

DRAWN: KLAU  
CHECKED: KLAU

DATE: Feb-20-15

TITLE: OUTLINE/CONNECTION DRAWING, LPR48-150-IP68

SIZE: B  
DWG NO: 0120048-08

REV: E  
REV: 1 OF 1

THESE DESIGNS AND SPECIFICATIONS ARE  
CONFIDENTIAL. REMAIN THE PROPERTY OF  
ALPHA TECHNOLOGIES LTD. NO PART IS TO BE  
COPIED OR USED WITHOUT ITS WRITTEN CONSENT

ALPHA TECHNOLOGIES™









**Alpha Technologies Ltd.**

7700 Riverfront Gate  
Burnaby, BC V5J 5M4  
Canada  
Tel: +1 604 436 5900  
Fax: +1 604 436 1233  
Toll Free: +1 800 667 8743  
www.alpha.ca

**Alpha Energy**

1628 W Williams Drive  
Phoenix, AZ 85027  
United States  
Tel: +1 623 251 3000  
Fax: +1 623 249 7833  
www.alphaenergy.us

**Alphatec Ltd.**

339 St. Andrews St.  
Suite 101 Andrea Chambers  
P.O. Box 56468  
3307 Limassol, Cyprus  
Tel: +357 25 375 675  
Fax: +357 25 359 595  
www.alpha.com

**Alpha Innovations S.A.**

1, Avenue Alexander Fleming  
B-1348 Ottignies, Louvain-la-Neuve  
Belgium  
Tel: +32 10 438 510  
Fax: +32 10 438 213  
www.alphainnovations.eu

**Alpha Technologies Turkey Enerji Ltd Sti**

Altaycesme Mah. Sarigul Sok. No: 33 Umut Kent  
Sitesi A Blok D:5  
Maltepe, Istanbul  
Turkey  
Tel: +90 216 370 23 28  
Fax: +90 216 370 23 68  
www.alpha.com.tr

**Alpha Technologies Inc.**

3767 Alpha Way  
Bellingham, WA 98226  
United States  
Tel: +1 360 647 2360  
Fax: +1 360 671 4936  
www.alpha.com

**Alpha Technologies GmbH.**

Hansastrasse 8  
91126  
Schwabach, Germany  
Tel: +49 9122 79889 0  
Fax: +49 9122 79889 21  
www.alphatechnologies.com

**Alpha Technologies Pty Ltd.**

Level 7  
91 Phillip Street  
Parramatta NSW 2150  
Australia  
Tel: +61 2 8599 6960  
www.alpha.com

**OutBack Power**

17825 59th Ave. NE, Suite B  
Arlington, WA 98223  
United States  
Tel: +1 360 435 6030  
Fax: +1 360 435 6019  
www.outbackpower.com

**Alpha Mexico Network Power S.A. de C.V.**

Montecito #38 (World Trade Center)  
Piso 37, Oficina 33  
Col. Nápoles, CDMX, C.P. 03810, México  
Tel: +55 5543 1114  
Toll Free: +01 800 0082 886  
www.alphapower.mx

**Alpha Industrial Power Inc.**

1075 Satellite Blvd NW.  
Suite 400  
Suwanee, GA 30024  
Tel: +1 678 475 3995  
Fax: +1 678 584 9259  
www.alpha.com

**Alpha Technologies Europe Ltd.**

Twyford House, Thorley  
Bishop's Stortford  
Hertfordshire, CM22 7PA  
United Kingdom  
Tel: +44 1279 501110  
Fax: +44 1279 659870  
www.alphatechnologies.com

**Alpha Innovations Brasil**

Address: Rua Alvares Cabral,  
Nº 338 – Diadema - SP  
09981-030  
Brazil  
Tel: +55 11 2476 0150  
www.alphainnovations.com.br

**Alpha Tec Trading Co. Ltd.**

Suite 1903, Tower 1,  
China Hong Kong City,  
33 Canton Road,  
Kowloon, Hong Kong  
Tel: +852 2736 8663  
Fax: +852 2199 7988  
www.alpha.com

**NavSemi Technologies Pvt Ltd.**

Vikas Plaza, Plot No. 38/1A (4),  
Electronic City Phase 2, Hosur Road,  
Bengaluru – 560100, Karnataka, India.  
Tel: +91 80 4123 0299  
www.navsemi.com

**Alpha Technologies Ltd.**member of The  Group™

Due to continuing product development, Alpha Technologies reserves the right to change specifications without notice.  
Copyright © 2018 Alpha Technologies. All Rights Reserved. Alpha® is a registered trademark of Alpha Technologies.

0120048-J0 (08/2018)