

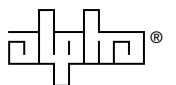

BSM-3 Battery Side Module Enclosure

Field Upgrade Installation Manual

Effective: May, 2003



Power Alpha Technologies 

BSM-3

Battery Side Module

Field Installation Manual

033-082-C0-002, Rev. B
May, 2003

Copyright © 2003 by
Alpha Technologies, Inc



NOTE: Alpha denies responsibility for any damage or injury involving its enclosures, power supplies, generators, batteries, or other hardware when used for an unintended purpose, installed or operated in an unapproved manner, or improperly maintained.



NOTE: Photographs contained in this manual are for illustrative purposes only. These photographs may not exactly match your installation.



NOTE: Review the drawings and illustrations contained in this manual before proceeding. If there are questions regarding the safe operation of this powering system, please contact Alpha Technologies or your nearest Alpha representative.

Contacting Alpha Technologies:

For general **product information and customer service**

1-800-863-3930

(7:00 AM to 5:00 PM Pacific Time)

For complete **technical support**

1-800-863-3364

(7:00 AM to 5:00 PM Pacific Time, or 24/7 emergency support)

Table of Contents

Preface	Safety Instructions	5
Preface	Safety Precautions	6
Preface	Battery Safety Notes	7
Preface	Installation Notes	8
1.1	BSM Installation	10
1.2	Tamper Switch Option	14
1.3	Enclosure Cooling Fan	16
1.4	Insulation Placement	17
1.5	Battery Installation	18
1.6	Part Numbers	22

List of Figures

Fig 1-1	Mounting Hole Location	11
Fig 1-2	Weather Strip Application	12
Fig 1-3	Tamper Switch Installation/Replacement	15
Fig 1-4	Fan Kit	16
Fig 1-5	Insulation Placement	17
Fig 1-6	RTS Placement	20
Fig 1-7	Battery Pack Wiring	21

Important Safety Instructions Contained In This Manual Read This Manual Before Proceeding!

Review the drawings and illustrations contained in this manual before proceeding. If there are any questions regarding the safe installation or operation of the system, contact Alpha Technologies or the nearest Alpha representative. Save this document for future reference.

To reduce the risk of injury or death caused by electrical shock, explosion of fuel or moving parts; and to ensure the continued safe operation of this product, the following symbols have been placed throughout this manual. Where these symbols appear, use extra care and attention.



DANGER VOLTAGE

This symbol indicates a “dangerous voltage” may exist in this area of the product. Use caution whenever working in the area to prevent electrical shock.



INHALATION HAZARD - DON'T BREATHE VAPORS

This symbol indicates an “inhalation hazard” may exist in this area of the product. Use caution whenever working in the area to prevent possible inhalation of harmful (fuel or exhaust) vapors.



NO MATCHES OR OPEN FLAMES

This symbol indicates a “fire or explosive hazard” may exist in this area of the product. Use caution whenever working in the area to prevent possible combustion of fuel vapors.



MECHANICAL OR MOVING PARTS HAZARD

These symbols indicate a “mechanical or moving parts hazard” may exist in this area of the product. Use caution whenever working in the area to prevent possible injury to the operator or service personnel.

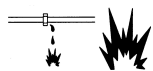

LEAK HAZARD

This symbol indicates a “leak hazard” may exist in this area of the product. Use caution whenever working in this area to prevent and correct any leaks detected.



ATTENTION

This symbol indicates important installation, operation or maintenance instructions. Always follow these instructions closely.



NOTE: Alpha Technologies' products are subject to change through continual improvement processes. Therefore, specifications and/or design layouts may vary slightly from descriptions included in this manual. Updates to the manual will be issued when changes affect form, fit or function.

General Safety Precautions

A “**Warning**” identifies conditions and actions that pose a hazard to the user.

A “**Caution**” identifies conditions and actions that may damage the power supply or associated equipment.

Warnings



NOTE: This enclosure and its associated hardware (power supply, batteries, cabling) may contain equipment, batteries or parts which have accessible hazardous voltage or currents.

To avoid injury:

- This enclosure and its associated hardware must be serviced by authorized personnel only.
- Enclosure must remain locked at all times, except when authorized service personnel are present.
- Remove all conductive jewelry or personal equipment prior to servicing equipment, parts, connectors, wiring, or batteries.
- Read and follow all installation, equipment grounding, usage, and service instructions included in this manual.
- Use proper lifting techniques whenever handling enclosure, equipment, parts, or batteries.
- Batteries contain dangerous voltages, currents and corrosive material. Battery installation, maintenance, service and replacement must be performed by authorized personnel only.
- Never use uninsulated tools or other conductive materials when installing, maintaining, servicing or replacing batteries.
- Use special caution when connecting or adjusting battery cabling. An improperly connected battery cable or an unconnected battery cable can result in arcing, a fire, or possible explosion.
- A battery that shows signs of cracking, leaking or swelling must be replaced immediately by authorized personnel using a battery of identical type and rating.
- Avoid any contact with gelled or liquid emissions from a valve-regulated lead-acid (VRLA) battery. Emissions contain dilute sulfuric acid which is harmful to the skin and eyes. Emissions are electrolytic, which are electrically conductive and are corrosive. Follow the Chemical Hazards notes if contact occurs.
- Do not smoke or introduce sparks in the vicinity of a battery.
- Under certain overcharging conditions, lead-acid batteries can vent a mixture of hydrogen gas which is explosive. Proper venting of the enclosure is required.
- Follow the battery manufacturer’s approved transportation and storage instructions.

Battery Safety Notes

Lead-acid batteries contain dangerous voltages, currents and corrosive material. Battery installation, maintenance, service and replacement must be performed by authorized personnel only.

Chemical Hazards



NOTE: Any gelled or liquid emissions from a valve-regulated lead-acid (VRLA) battery contain dilute sulfuric acid, which is harmful to the skin and eyes. Emissions are electrolytic, which are electrically conductive and corrosive.

To avoid injury:

- Servicing and connection of batteries shall be performed by, or under the direct supervision of, personnel knowledgeable of batteries and the required safety precautions.
- Always wear eye protection, rubber gloves, and a protective vest when working near batteries. Remove all metallic objects from hands and neck.
- Batteries produce explosive gases. Keep all open flames and sparks away from batteries.
- Use tools with insulated handles, do not rest any tools on top of batteries.
- Batteries contain or emit chemicals known to the State of California to cause cancer and birth defects or other reproductive harm. Battery post terminals and related accessories contain lead and lead compounds. Wash hands after handling. (California Proposition 65)
- Wear protective clothing (insulated gloves, eye protection, etc) whenever installing, maintaining, servicing, or replacing batteries.
- If any battery emission contacts the skin, wash immediately and thoroughly with water. Follow your company's approved chemical exposure procedures.
- If any battery emission contacts the eye, wash immediately and thoroughly with water for 10 minutes with pure water or a special neutralizing eye wash solution and seek immediate medical attention. Follow your company's approved chemical exposure procedures.
- Neutralize any spilled battery emission with the special solution contained in an approved spill kit or with a solution of 1 lb. Bicarbonate of soda to 1 gal of water. Report chemical spill using your company's spill reporting structure and seek medical attention if necessary.
- Always replace batteries with those of an identical type and rating. Never install old or untested batteries.
- Do not charge batteries in a sealed container. Each individual battery should have at least 0.5 inches of space between it and all surrounding surfaces to allow for convection cooling.
- All battery compartments must have adequate ventilation to prevent an accumulation of potentially dangerous gas.

Battery Safety Notes, *continued*

- Prior to handling the batteries, touch a grounded metal object to dissipate any static charge that may have developed on your body.
- Never use uninsulated tools or other conductive materials when installing, maintaining, servicing or replacing batteries.
- Use special caution when connecting or adjusting battery cabling. An improperly connected battery cable or an unconnected battery cable can make contact with an unintended surface that can result in arcing, fire, or possible explosion.
- A battery showing signs of cracking, leaking, or swelling should be replaced immediately by Authorized Personnel using a battery of identical type and rating.
- Under extreme overcharging conditions, Lead-acid batteries can vent a mixture of Hydrogen gas which is explosive.

Battery Maintenance Guidelines

The battery maintenance instructions listed below are for reference only. Battery manufacturer's instructions for transportation, installation, storage or maintenance take precedence over these instructions.

- To prevent damage, inspect batteries every 3 months for:
 - Signs of battery cracking, leaking or swelling.* The battery should be replaced immediately by authorized personnel using a battery of the identical type and rating.
 - Signs of battery cable damage.* Battery cable should be replaced immediately by Authorized Personnel using replacement parts specified by vendor.
 - Loose battery connection hardware.* Refer to battery manufacturer's documentation for the correct torque and connection hardware for the application.
- Apply battery manufacturer's specified antioxidant compound on all exposed connections.
- Verify battery terminals and/or exposed connection hardware is not within 2 inches of a conductive surface. Reposition batteries as necessary to maintain adequate clearance.
- Clean up any electrolyte (battery emission) in accordance with all federal, state, and local regulations or codes.
- Proper venting of the enclosure is recommended. Follow the Battery Manufacturer's approved transportation and storage instructions.
- Always replace batteries with those of an identical type and rating. Never install old or untested batteries.

Recycling and Disposal Instructions

- Spent or damaged batteries are considered environmentally unsafe. Always recycle used batteries or dispose of the batteries in accordance with all federal, state and local regulations.

Electrical Safety

- Lethal voltages are present within the power supply and electrical boxes. Never assume that an electrical connection or conductor is not energized. Check the circuit with a volt meter with respect to the grounded portion of the enclosure (both AC and DC) prior to any installation or removal procedure.
- Do not work alone under hazardous conditions.
- A licensed electrician is required to install permanently wired equipment.
- Input voltages can range up to 240 VAC. Ensure that utility power is disabled before beginning installation or removal.
- Ensure no liquids or wet clothes contact internal components.
- Hazardous electrically live parts inside this unit are energized from batteries even when the AC input power is disconnected from the Mini-Bay.

Mechanical Safety

- Keep hands and tools clear of fans. Fans are thermostatically controlled and will turn on automatically.
- Power supplies can reach extreme temperatures under load.
- Use caution around sheet metal components and sharp edges.

1. Installation

1.1 BSM Installation

Overview

The Battery Side Module was designed to allow the customer to add additional batteries in the field for additional standby/run time. The BSM-3 was designed for use with the UPE-M3 enclosure only.



WARNING: DO NOT install a BSM-3 on both sides of the UPE-M3, or install a second power supply in the UPE-M3, to do so will void your warranty and result in thermal damage to the power supply and battery packs.

Upon receipt, the enclosure should be unpacked and inspected for shipping damage. The following items should be enclosed:

1. BSM-3 Enclosure and door, with two sets of keys.
2. 6 aluminum rivets and 2 sets of #10 nuts and bolts for mounting the BSM-3.
3. Battery cable conduit, consisting of a chase nipple, lock washer and bushing.
4. Self adhesive insulation pads, and weather stripping.
5. Battery Cable Kit (Alpha P/N 874-479-22).

1.1.1. Enclosure Preparation

Tools and Materials Needed:

Center Punch or Permanent Marker
Tape measure
Electric or pneumatic drill
No. 7 drill bit (.203")
#2 Phillips screw driver
Hand operated rivet gun with .188" nosepiece
Drill-stop collar for No. 7 drill bit
Hole saw or hydraulic punch for 1.375" hole
Wet-dry vacuum
Utility knife
1" Chase nipple (supplied)
1" locknut (supplied)
1" plastic bushing (supplied)
Enclosure Cooling Fan Kit (if not previously installed)
6 aluminum rivets (supplied)
2 #10-32 x 3/4" pan-head screws (supplied)
2 #10-32 Nuts (supplied)
4 #10 Paint-Break washers (supplied)

Procedure:



NOTE: Metal shavings will enter the UPE-M3 enclosure during this procedure. Before proceeding, verify that the power supply, CB box, Service Entrance and batteries are disconnected and protected.

1.1 BSM Installation, *continued*

1.1.1. Enclosure Preparation, *continued*



WARNING: Follow all manufacturer's operating and safety instructions for the use of power tools and punch drivers

1. Place the Battery Side Module (BSM) on the pad beside the UPE-M3 enclosure (Fig. 1-1). Slide the BSM-3 against the side of the UPE-M3, ensuring that the top edge of the BSM-3 rests between the rows of louvers.

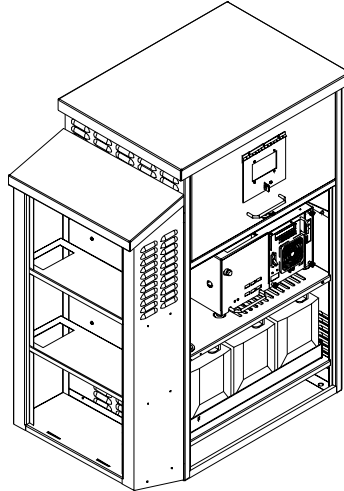

2. Using the holes in the inside flange of the BSM-3 as a template, mark the eight holes on the UPE-M3 enclosure with a punch or marker. Mark the location of the 1.375" cable conduit hole.

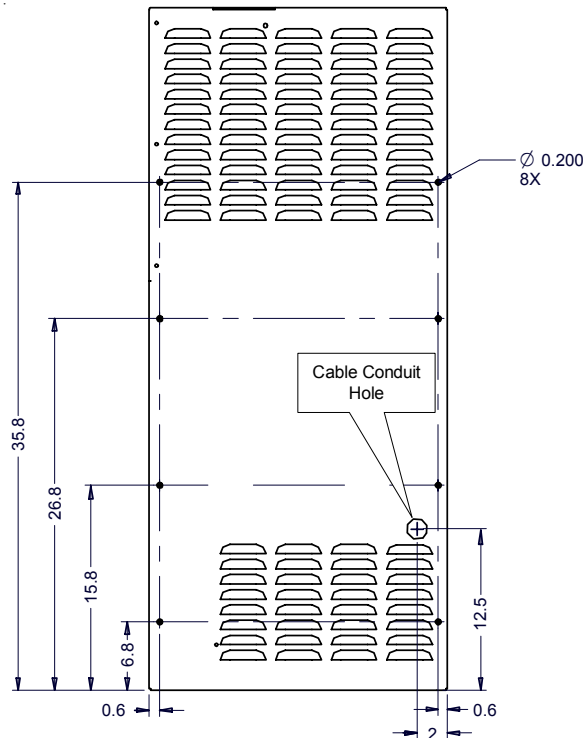

Fig 1-1 Mounting Hole Locations

1. Installation

1.1 BSM Installation, *continued*

1.1.1. Enclosure Preparation, *continued*

3. Install weather stripping (included) to the mounting surfaces of the BSM-3, as shown below. Ensure stripping meets to form a water tight seal at the top corners. Do not apply weather stripping to the bottom edge of the BSM-3.

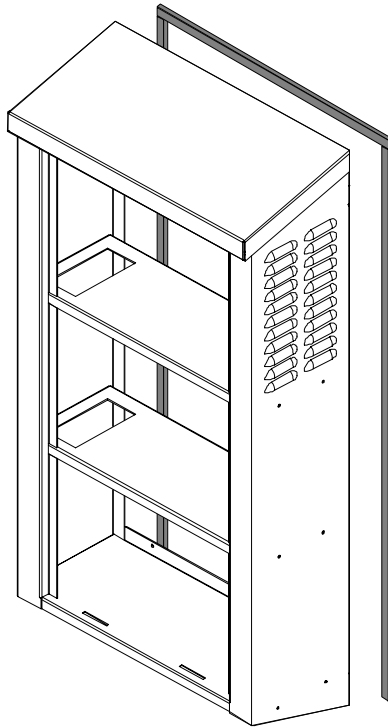

Fig 1-2 Weather Strip Application

1.1 BSM Installation, *continued*

1.1.1. Enclosure Preparation, *continued*



CAUTION: Do not drill through the inner wall of the UPE-M3 when drilling the upper rivet holes. **Doing so will violate E.U.S.E.R.C. code.**

4. Using No. 7 drill bit, with Drill-Stop collar set 1" from drill tip, drill the holes marked in step 2.
6. Using a hole saw or punch driver, drill the 1.375" hole for the cable conduit marked in step 2.
7. Use a utility knife or de-burring tool to remove any sharp edges from around conduit hole.
8. Place the BSM-3 into position, and align the holes.



NOTE: To provide proper grounding, two of the rivet holes must be filled with stainless steel screws and nuts, with paint-break washers against the enclosures, as shown below. The bottom set of holes are recommended.

9. Rivet and bolt the BSM-3 into place using the aluminum rivets and stainless steel hardware provided. See diagram Below.

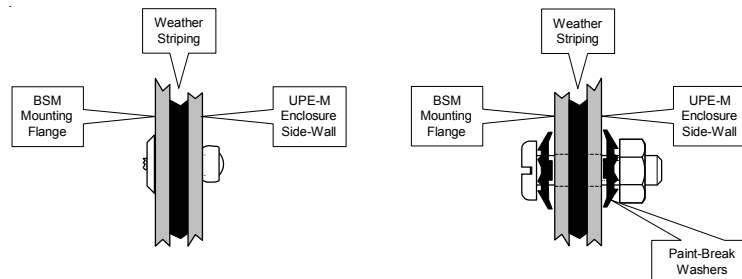

10. Install the 1" chase nipple, locknut and bushing into the 1.375" conduit hole, as shown below.

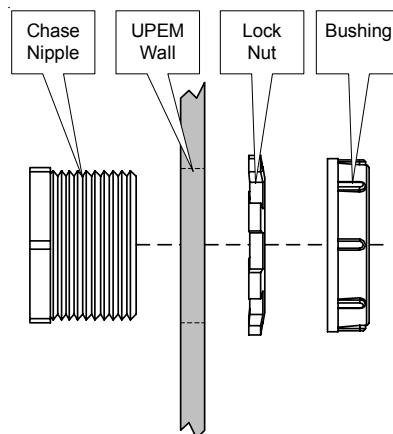

11. Vacuum the metal shavings from the UPE-M3 and the BSM-3.

1. Installation

1.2 Dual Tamper Switch Option

1.2.1. Tamper Switch Installation

The Dual Tamper Switch option allows the USM2 or USM2.5 Communications Card to monitor both the UPE-M3 door and the BSM-3 door.

Tools and Materials Needed:

- #2 Phillips Screwdriver
- 5/16" Nut Driver
- 4 Sheet metal screws (supplied)
- 4 #6-32 nuts (supplied)
- 4 #6 Lock washers (supplied)
- Dual pre-wired tamper switch harness (supplied)

Procedure:

1. If installed, unplug the existing tamper switch connector from the front of the power supply in the UPE-M3 enclosure.
2. If installed, use a screwdriver to remove the wired portion of the tamper switch, located on the front left corner of the power supply shelf. Remove switch and wiring from the enclosure.
3. Route the new tamper switches and connector through the cable conduit between the UPE-M3 and BSM-3 enclosures. See Fig. 1-3 (A), on the following page.
4. Using the predrilled holes, install the new tamper switch on the left side of the power supply shelf in the UPE-M3 and on the upper left door jamb in the BSM-3, using the sheet metal screws and lock washers provided in the tamper switch kit. See Fig. 1-3 (C)
5. If not previously installed, attach the magnet portion of the tamper switches to the studs on the doors directly opposite the switch, with the #6-32 nuts and lock washers included in the tamper switch kit. See Fig. 1-3 (B).
6. Connect the tamper switch cable connector to the jack on the front of the power supply labeled Tmpr. See Fig. 1-3 (A).
7. Secure the tamper switch wires so that they will not be damaged by the doors or sliding trays.

1.2 Dual Tamper Switch Option, *continued*

1.2.1. Tamper Switch Installation, *continued*

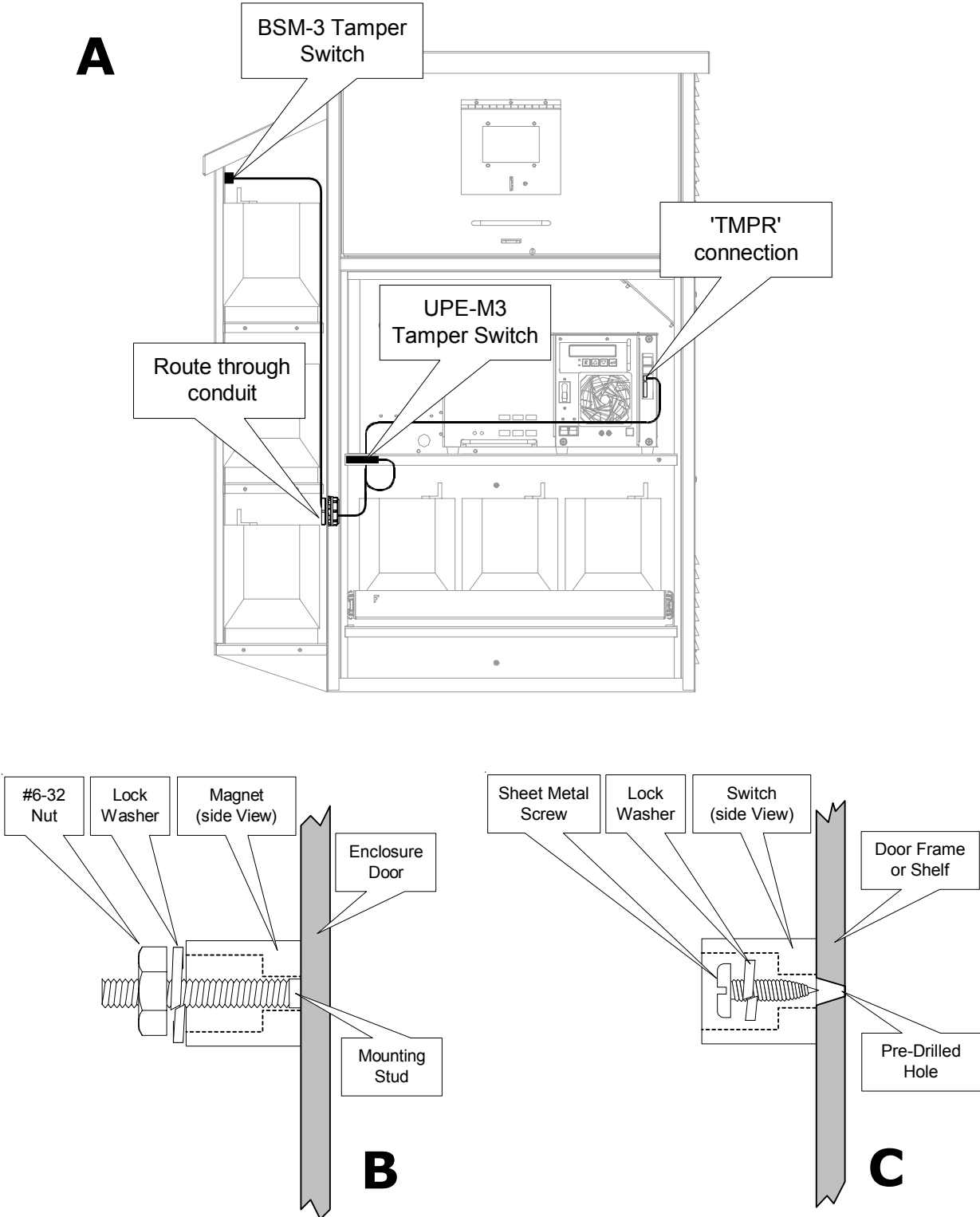

Fig 1-3 Tamper Switch Replacement / Installation

1. Installation

1.3 Enclosure Cooling Fan

1.3.1. Cooling Fan

Tools and Materials Needed:

3/8" Nut-driver or open end wrench
UPEM Fan Kit (Alpha P/N 744-797-24)

Procedure:



CAUTION: Due to restricted air flow, an enclosure cooling fan **MUST** be installed in the UPE-M3 enclosure when using a Battery Side Module.

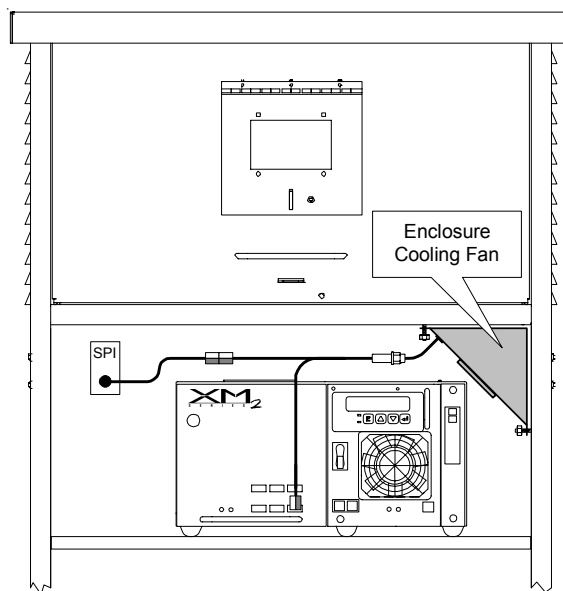

Fig 1-4 Fan Kit

Refer to the UPEM Series installation manual (P/N 031-145-C0) for detailed instructions on installing the fan kit.

1.4 Insulation Installation

1.4.1. Insulation Pad Placement

Tools and Materials Needed:

Foam insulation (supplied)
Utility knife

Procedure:



CAUTION: To prevent thermal overload of the power supply and batteries, an insulating pad **MUST** be placed in the power supply compartment of the UPEM enclosure.

1. Insulation pads are pre-cut to proper size. When installing on the left side of the enclosure, use the 12" X 13.5" pad. When installing on the right, use the 7" X 13.5" pad. Insulate only the side facing the BSM-3.
2. Peel the cover off the adhesive, and place against the side of the enclosure, as shown below. Dispose of unused insulation pad.

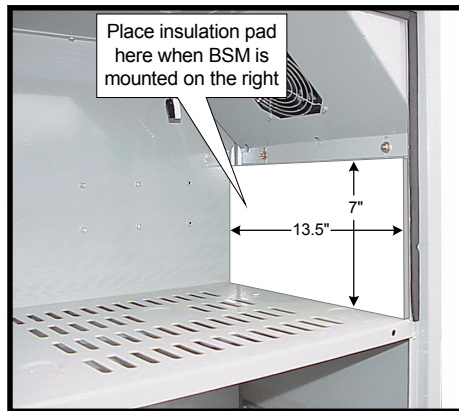

BSM-3 mounted on the right

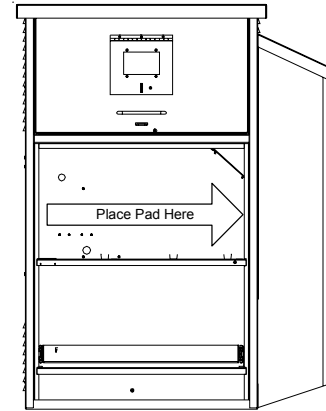

BSM-3 mounted on the left

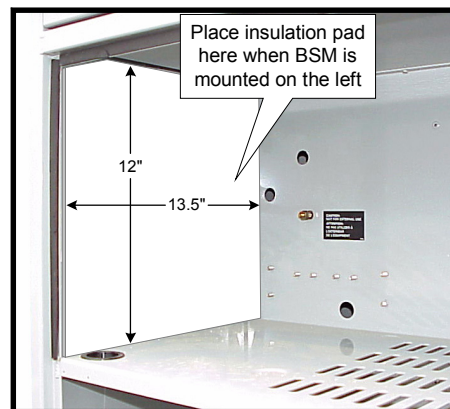
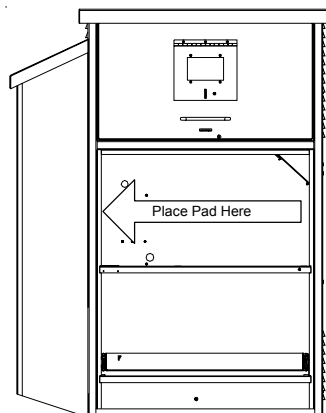

Fig 1-5 Insulation Placement

1. Installation

1.5 Battery Installation

1.4.1. Date Code

Each battery contains a DATE CODE usually located on a sticker near the center of the battery or stamped in white ink near the POS terminal. This date code must be recorded in the battery's maintenance log. If batteries other than those installed by Alpha are used, consult the battery's manufacturers' documentation for date code type and placement.

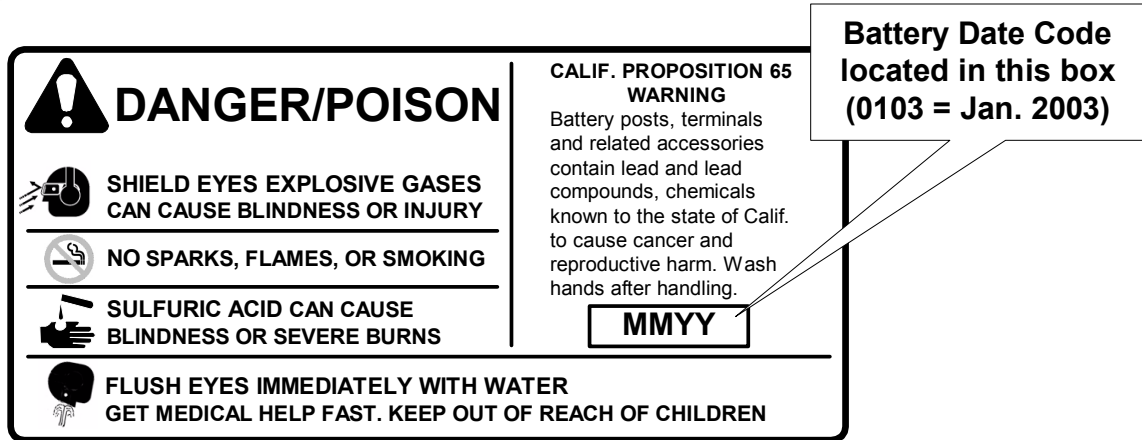

1.4.2. Battery Terminals

The accompanying drawings are for *illustrative* purposes only. Various types of batteries with different mounting styles and hardware may be shipped with the system. ALWAYS refer to the battery manufacturers' specifications for correct mounting hardware and torque requirements. During maintenance procedures, refer to the manufacturers' specifications for the maintenance torque requirements.

For AlphaCell batteries, use 65 Inch-Pounds upon installation, then re-torque to 50 Inch-Pounds during maintenance.

Mounting hardware requirements may vary with battery manufacturers. Use only the hardware recommended by your particular battery manufacturer.

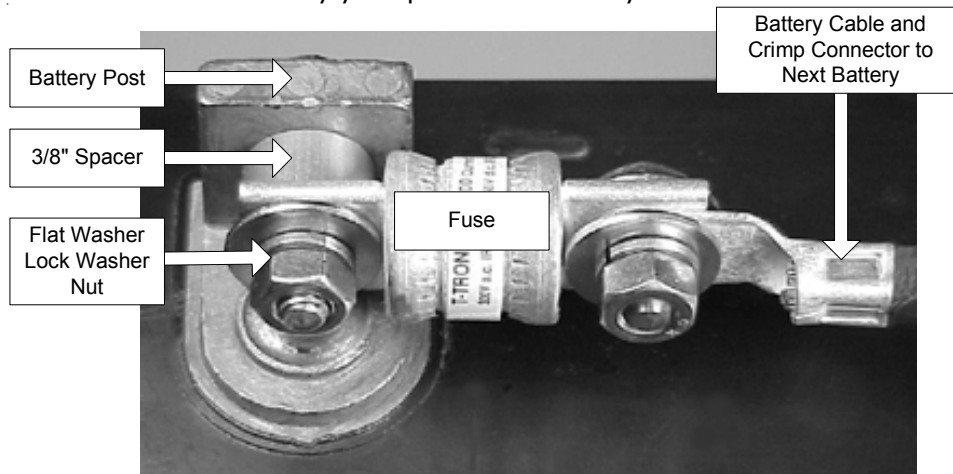

1.5 Battery Installation, *continued*

1.5.1 Battery Connection

Tools and Materials Needed:

Two 7/16" open end wrenches
 Battery Cable Kit, BSM-3 (Alpha P/N 874-497-22)

Procedure:

WARNING: Set the **BATTERY BREAKER** on the power supply to **OFF**.

To prevent short circuits, route only ONE wire at a time through the cable conduit. Attach the cable at both ends before routing the second cable through.

1. Install 3 batteries into the BSM-3 as shown in Fig. 1-4



NOTE: When attaching cables to the battery pack in the UPE-M3, place the termination on the opposite side of the battery post from the existing wire.

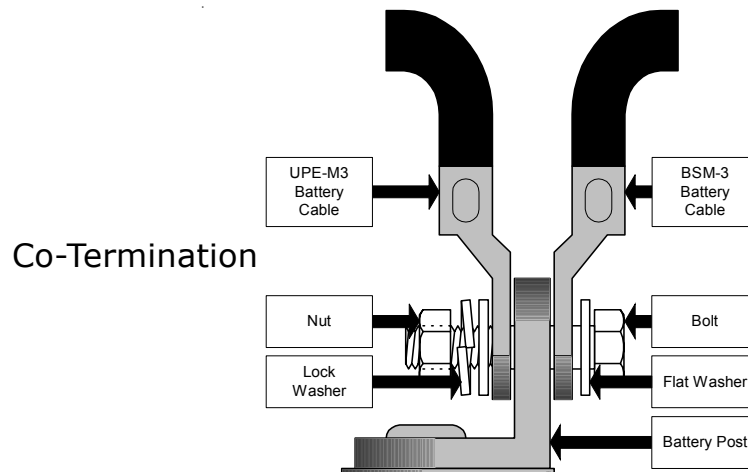

2. Install the battery cable kit one wire at a time. Connect both ends before installing the next wire to avoid short circuits.
3. Set the **BATTERY BREAKER** on the front of the power Supply to the **ON** position



NOTE: If battery wires for status monitoring are to be installed, refer to the transponder manufacturers instructions for wiring diagrams. Install the fuse in the location shown on the battery wiring diagram.

1. Installation

1.5 Battery Installation, *continued*

Battery Remote Temperature Sensor (RTS)

Tools Needed:

Adhesive Tape

Procedure:

1. Attach the RTS Probe to the inner side of the center battery in the UPE-M3 enclosure with adhesive tape (see Fig. 1-4).
2. For enclosures with multiple battery strings, the RTS must be located with the WARMEST battery string. This ensures proper operation of the battery charger's temperature compensation circuit. Failure to locate the RTS with the warmest battery string could result in overcharging and premature battery failure.
3. The other side of the RTS Probe is attached to the front panel of the XM Series 2 power supply, in the UPE-M3 enclosure.

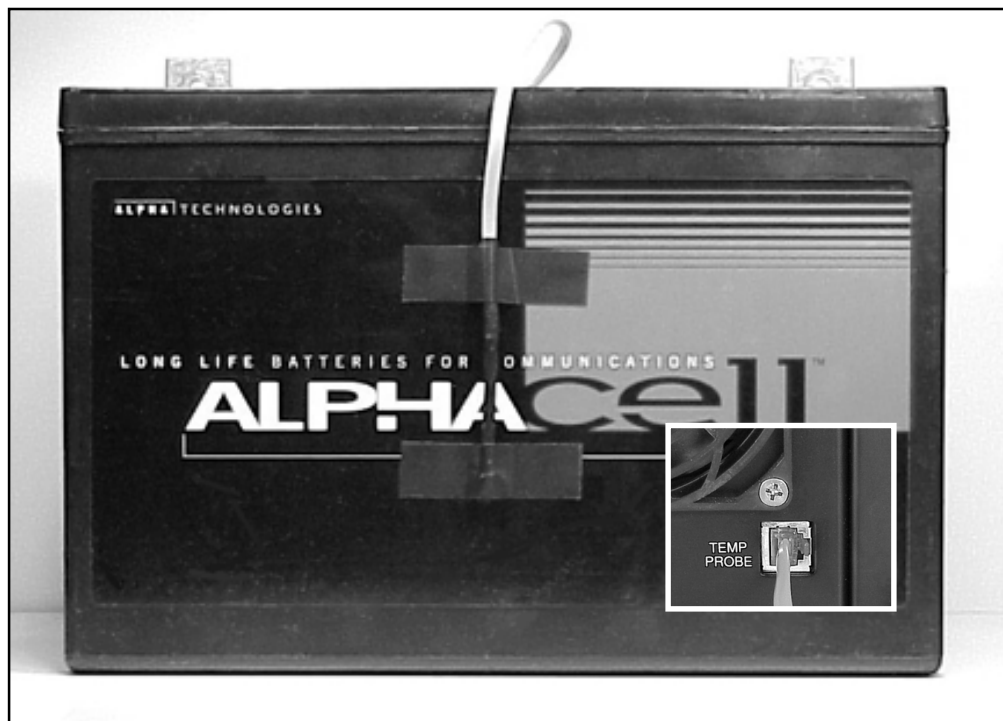

Fig. 1-6 Battery Remote Temp Sensor (RTS) placement

1.5 Battery Installation, *continued*

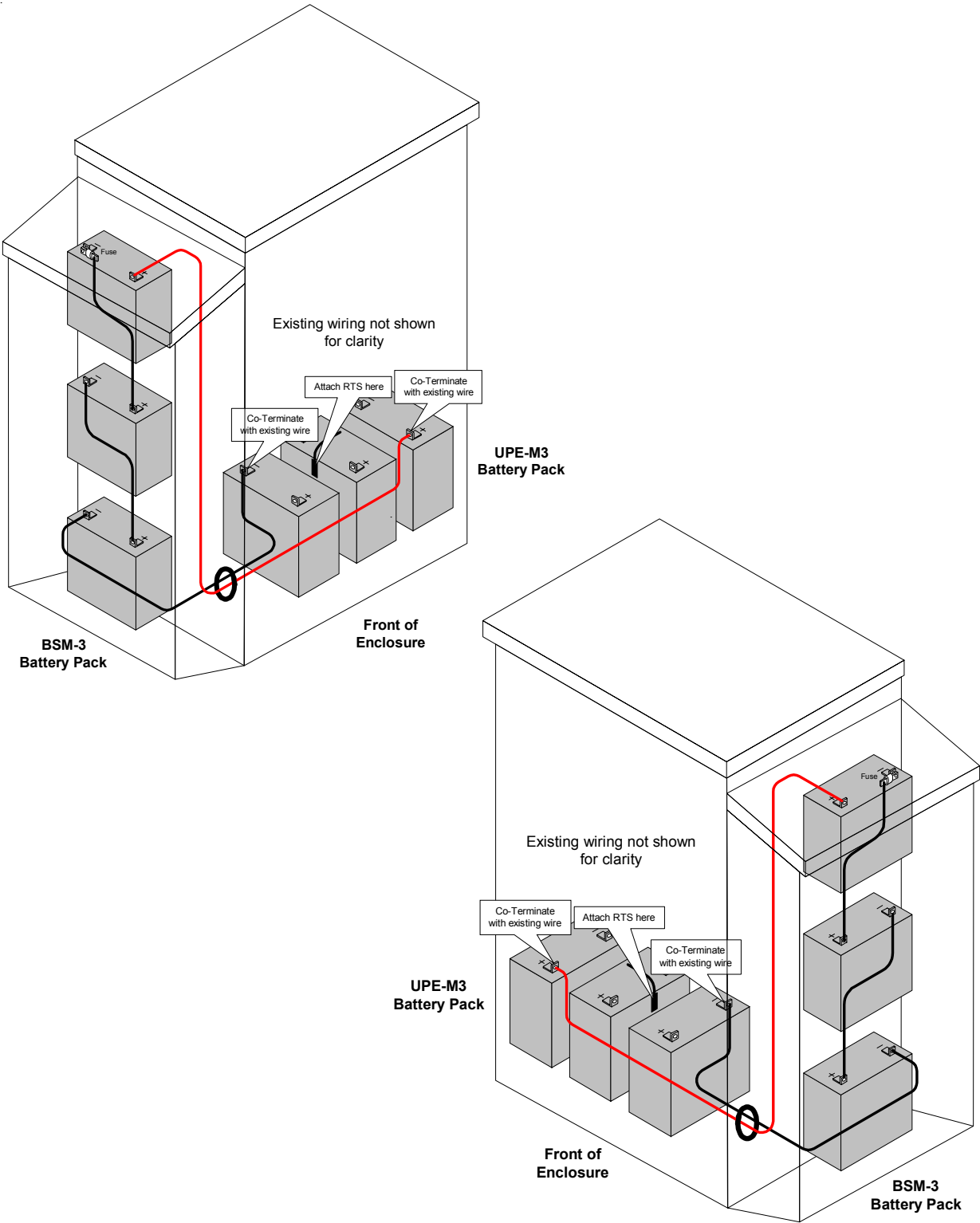

Fig 1-7 UPE-M3 / BSM-3 Battery Pack

1. Installation

1.6 Part Numbers

BSM-3 Ground Mount Enclosure	033-082-20
BSM-3 Battery Cable Kit	874-479-22
BSM-3 Tamper Switch Kit	874-958-20

Power

Alpha Technologies

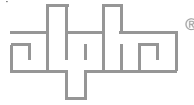

Corporate

Alpha Technologies
3767 Alpha Way
Bellingham, WA 98226

USA

Tel: (360) 647-2360
Fax: (360) 671-4936
Web: www.alpha.com

Alpha Technologies Ltd.
4084 McConnell Court
Burnaby, BC, V5A 3N7

CANADA

Tel: (604) 430-1476
Fax: (604) 430-8908

Alpha Technologies
Europe Ltd.
Cartel Business Estate
Edinburgh Way
Harlow, Essex CM20 2TT

UNITED KINGDOM

Tel: +44-1279-422110
Fax: +44-1279-423355

Alpha Technologies
Hansastrasse 8
D-91126 Schwabach

GERMANY

Tel: +49-9122-79889-0
Fax: +49-9122-79889-21

Alphatec
339 St. Andrews Street
Suite 101
Andrea Chambers
Limassol, Cyprus

CYPRUS

Tel: +357-25-375675
Fax: +357-25-359595

Alpha Technologies
Unit R5-R7 Regents Park Estate
Corner Park Rd and Prince's Rd East
Regents Park, NSW 2143

AUSTRALIA

Tel: +61-2-9722-3320
Fax: +61-2-9722-3321